

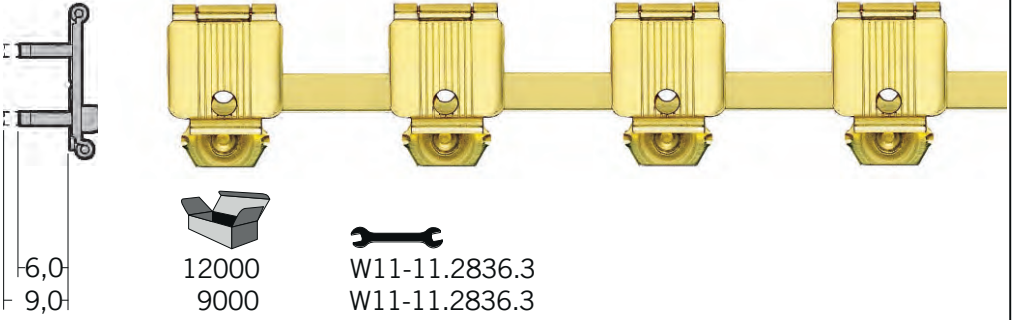

Verschlüsse auf Rollen  
 Clasps on rolls  
 Fermeurs en rouleaux  
 Cierres en rollos  
 Fermagli in rotoli



1111 - 2836.36. = 6,0  
 1111 - 2836.39. = 9,0

12000  
 9000

W11-11.2836.3  
 W11-11.2836.3



1111 - 2973.36. = 6,0  
 1111 - 2973.39. = 9,0

12000  
 9000

W11-11.2836.3  
 W11-11.2836.3



1111 - 2896.36. = 6,0  
 1111 - 2896.39. = 9,0

10000  
 9000

W11-11.2836.3  
 W11-11.2836.3



1111 - 2927.36. = 6,0  
 1111 - 2927.39. = 9,0

12000  
 9000

W11-11.2836.3  
 W11-11.2836.3

Verschlüsse auf Rollen  
 Clasps on rolls  
 Fermeurs en rouleaux  
 Cierres en rollos  
 Fermagli in rotoli

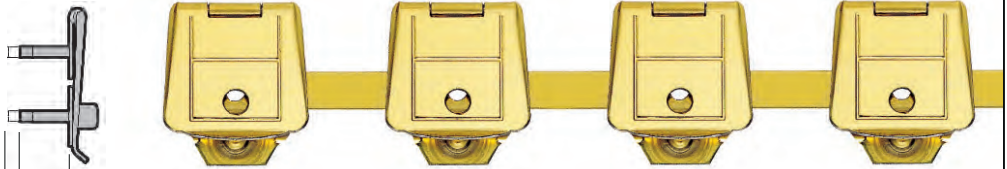

1111 - 3013.36. = 6,0  
 1111 - 3013.39. = 9,0

12000  
 9000

W11-11.2836.3  
 W11-11.2836.3

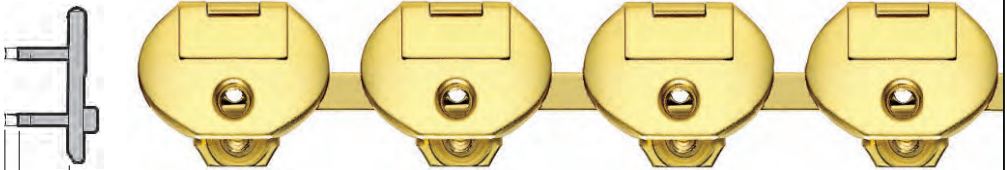

1111 - 3051.36. = 6,0  
 1111 - 3051.39. = 9,0

12000  
 9000

W11-11.2836.3  
 W11-11.2836.3



1111 - 3024.36. = 6,0  
 1111 - 3024.39. = 9,0

10000  
 9000

W11-11.2836.3  
 W11-11.2836.3





1111 - 2859.36. = 6,0  
 1111 - 2859.39. = 9,0

12000  
 9000

W11-11.2836.3  
 W11-11.2836.3



Verschlüsse auf Rollen  
 Clasps on rolls  
 Fermoins en rouleaux  
 Cierres en rollos  
 Fermagli in rotoli

10000  
9000





W11-11.2836.3  
W11-11.2836.3

10000  
9000



W11-11.2836.3  
W11-11.2836.3





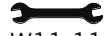

10000  
9000



W11-11.2836.3  
W11-11.2836.3

Verschlüsse auf Rollen  
 Clasps on rolls  
 Fermairs en rouleaux  
 Cierres en rollos  
 Fermagli in rotoli



1111 - 2873.36. = 6,0  
 1111 - 2873.39. = 9,0



10000  
9000



W11-11.2836.3  
W11-11.2836.3

1111 - 2873.66. = 6,0  
 1111 - 2873.69. = 9,0





10000  
9000



W11-11.2836.3  
W11-11.2836.3

mit Druckknopf  
 with press button  
 avec bouton pression  
 con botón a presión  
 con bottone a pressione

1111 - 2851.36. = 6,0  
 1111 - 2851.39. = 9,0





10000  
9000

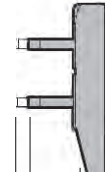

W11-11.2836.3  
W11-11.2836.3

mit Federung  
 with spring  
 avec ressort  
 con resorte  
 a molia

1111 - 3042.36. = 6,0  
 1111 - 3042.39. = 9,0



9000  
9000



W11-11.2836.3  
W11-11.2836.3

mit Druckknopf  
 with press button  
 avec bouton pression  
 con botón a presión  
 con bottone a pressione



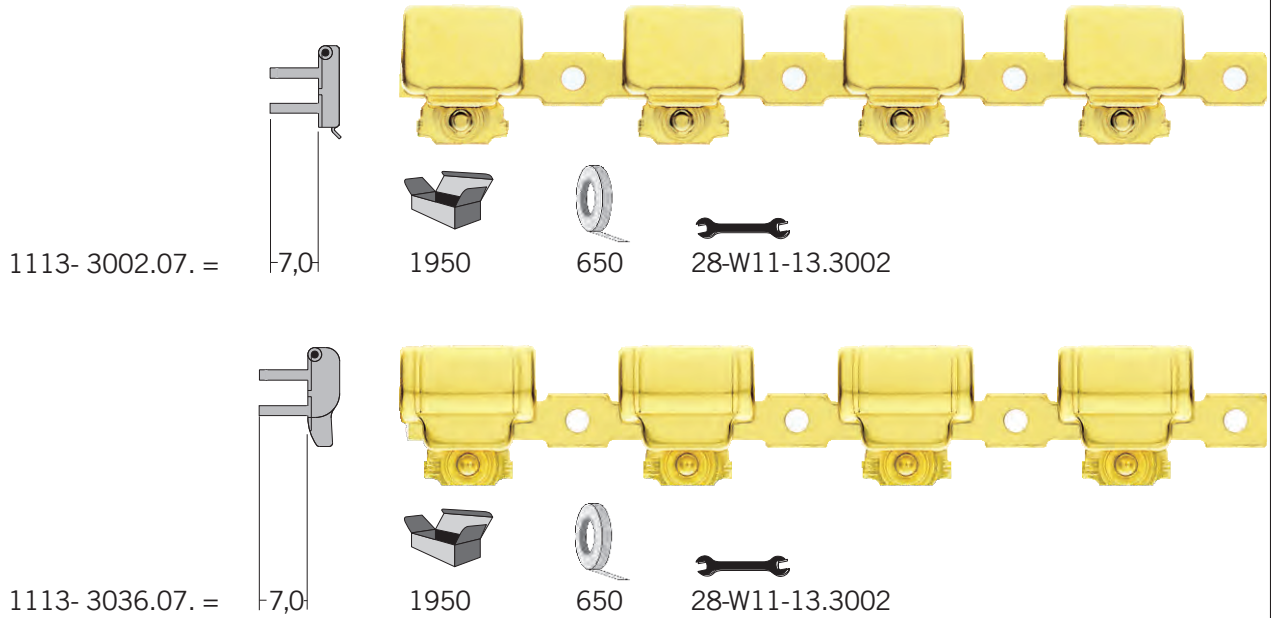







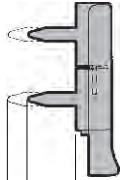

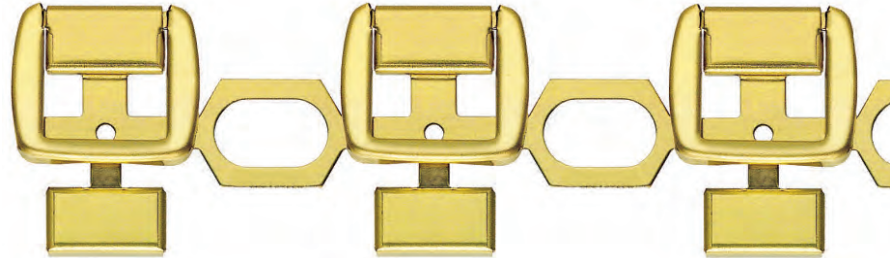

Spitzenverschlüsse auf Rollen  
 Clinch clasps on rolls  
 Fermoirs à griffes en rouleaux  
 Cierres de puntas en rollos  
 Fermagli a punta in rotoli

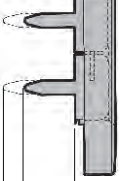



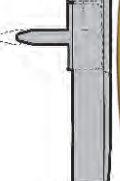









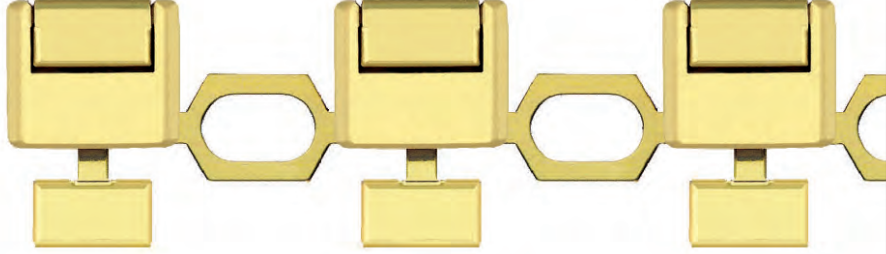

Weitere Varianten auf Anfrage  
 Other variations available upon enquiry  
 Autres variantes sur demande  
 Más variantes a pedido del cliente  
 Altre varianti su richiesta

natürliche Größe  
 actual size  
 grandeur naturelle  
 tamaño natural  
 grandezza naturale

Verschlüsse mit Feder, auf Rollen  
 Clasps with spring, on rolls  
 Fermoins avec ressort, en rouleaux  
 Cierres con resorte, en rollos  
 Fermagli con molla, in rotoli

 1121-2985.07. = 7,0 1121-2985.00. = 10,5		 4000 3200	 W11-21.2985 W11-21.2985
 1121-3001.07. = 7,0 1121-3001.00. = 10,5		 4000 3200	 W11-21.2985 W11-21.2985
 1121-3000.07. = 7,0 1121-3000.00. = 10,5		 4000 3200	 W11-21.2985 W11-21.2985
 1121-2999.07. = 7,0 1121-2999.00. = 10,5		 3500 2800	 W11-21.2985 W11-21.2985

Verschlüsse mit Feder, auf Rollen  
 Clasps with spring, on rolls  
 Fermairs avec ressort, en rouleaux  
 Cierres con resorte, en rollos  
 Fermagli con molla, in rotoli

 <p>1121-3050.07. = 7,0            1121-3050.00. = 10,5</p>		 <p>4000 3200</p>	 <p>W11-21.2985 W11-21.2985</p>
 <p>1121-3085.07. = 7,0            1121-3085.00. = 10,5</p>		 <p>4000 3200</p>	 <p>W11-21.2985 W11-21.2985</p>
 <p>1121-3033.07. = 7,0            1121-3033.00. = 10,5</p>		 <p>4000 3200</p>	 <p>W11-21.2985 W11-21.2985</p>
 <p>1121-3039.07. = 7,0            1121-3039.00. = 10,5</p>		 <p>3500 2800</p>	 <p>W11-21.2985 W11-21.2985</p>

Verschlüsse mit Feder, auf Rollen, für flache Deckel  
 Clasps with spring, on rolls, for flat lids  
 Fermoirs avec ressort, en rouleaux, pour couvercles plats  
 Cierres con resorete, en rollos, para tapas planas  
 Fermagli con molla, in rotoli, per coperchio piatto

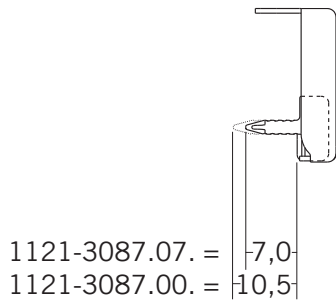

5000  
4000

existing tool



W11-21.2985 + W11-21-3087

W11-21.2985 + W11-21-3087

modification set



new tool



28-W11-21.3087-K

28-W11-21.3087-K

Weitere Varianten auf Anfrage  
 Other variations available upon enquiry  
 Autres variantes sur demande  
 Más variantes a pedido del cliente  
 Altre varianti su richiesta





Verschlüsse auf Rollen  
Clasps on rolls  
Ferroirs en rouleaux  
Cierres en rollos  
Fermagli in rotoli

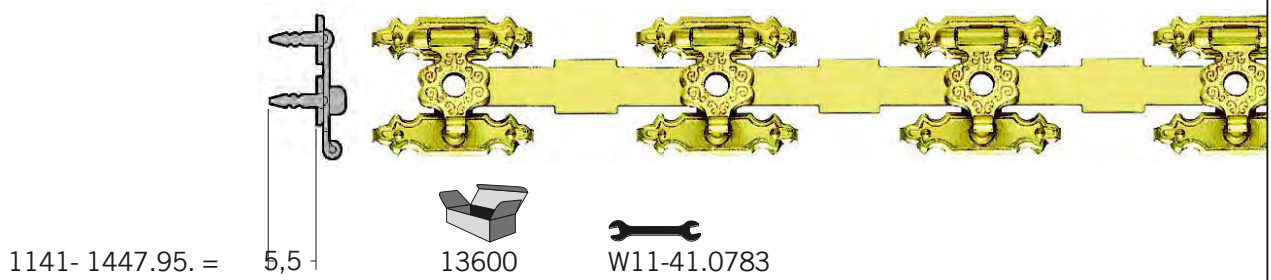
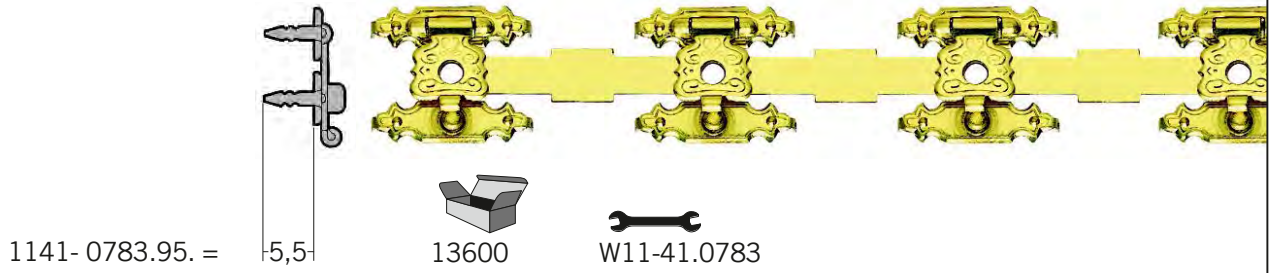

Verschlüsse auf Rollen  
 Clasps on rolls  
 Fermoins en rouleaux  
 Cierres en rollos  
 Fermagli in rotoli

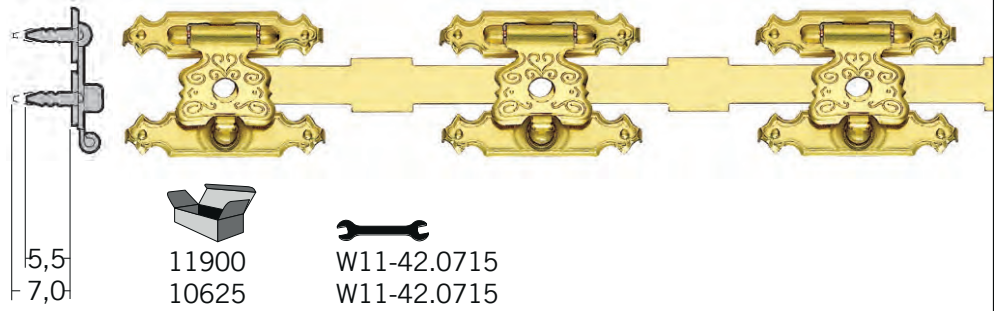

1142-0715.95. = 5,5  
 1142-0715.97. = 7,0

11900  
 10625

W11-42.0715  
 W11-42.0715

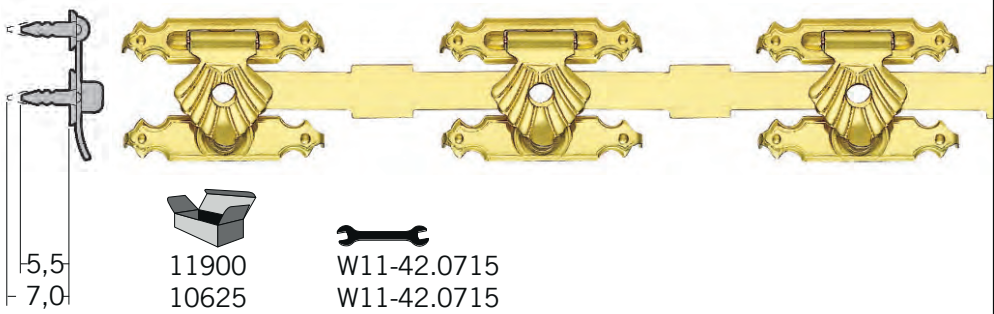

1142-1734.95. = 5,5  
 1142-1734.97. = 7,0

11900  
 10625

W11-42.0715  
 W11-42.0715

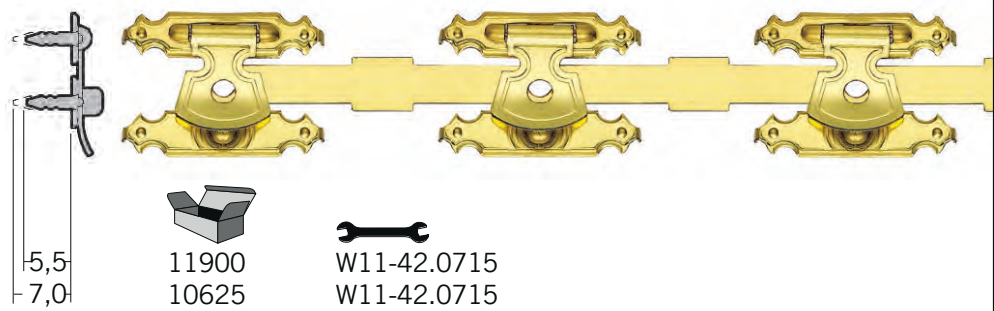

1142-0607.95. = 5,5  
 1142-0607.97. = 7,0

11900  
 10625

W11-42.0715  
 W11-42.0715

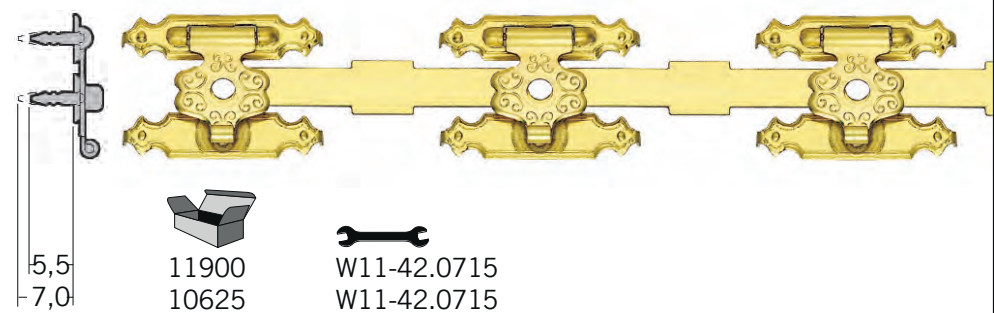













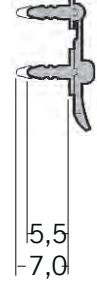
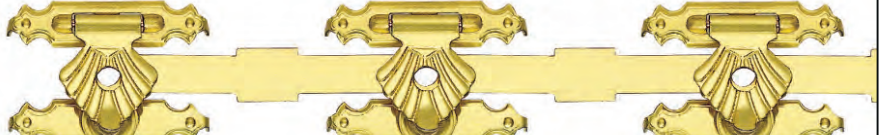

1142-1408.95. = 5,5  
 1142-1408.97. = 7,0

11900  
 10625

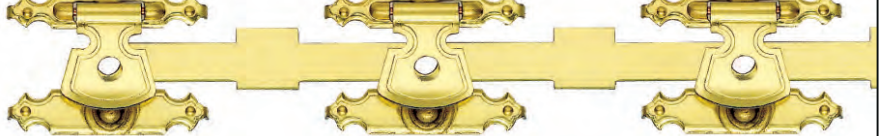
W11-42.0715  
 W11-42.0715

Verschlüsse für flache Deckel, auf Rollen  
 Clasps for lids, on rolls  
 Fermeurs pour couvercles plats, en rouleaux  
 Cierres para tapas planas, en rollos  
 Fermagli per coperchio piatto, in rotoli



1142- 0458.95. = 1142- 0458.97. =			 11900 10625	 W11-42.0715-1 W11-42.0715-1
1142- 1917.95. = 1142- 1917.97. =			 11900 10625	 W11-42.0715-1 W11-42.0715-1
1142- 1167.95. = 1142- 1167.97. =			 11900 10625	 W11-42.0715-1 W11-42.0715-1
1142- 0713.95. = 1142- 0713.97. =			 11900 10625	 W11-42.0715-1 W11-42.0715-1

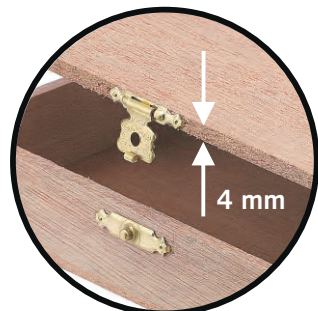

Spitzenverschlüsse mit Druckknopf auf Rollen  
 Clinch clasps with press button on rolls  
 Fermoirs à griffes avec bouton pression en rouleaux  
 Cierres de puntas con botón de presión en rollos  
 Fermagli a punta con bottone a pressione in rotoli

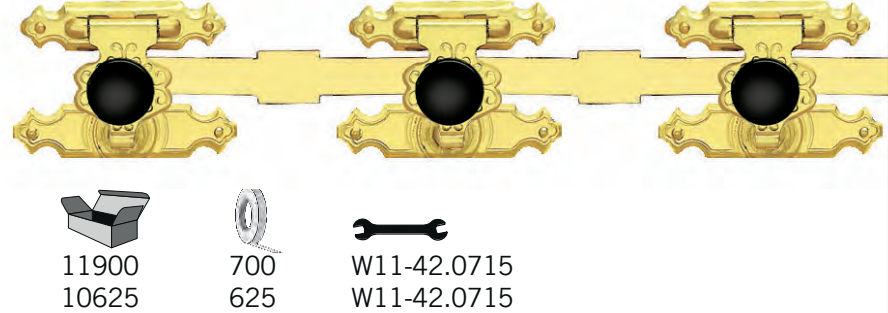
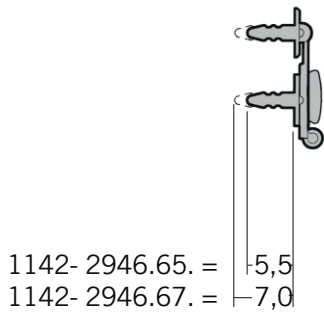
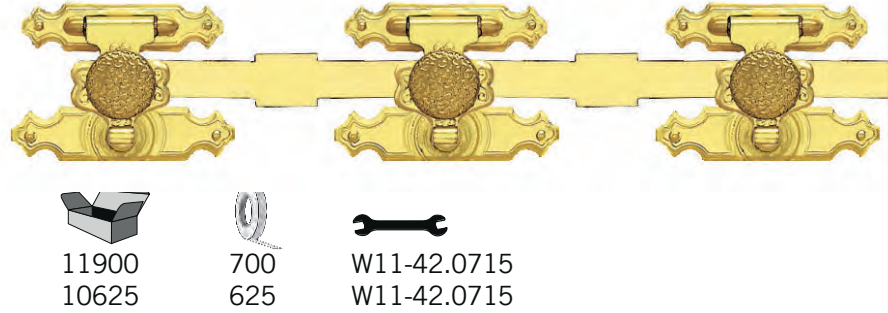
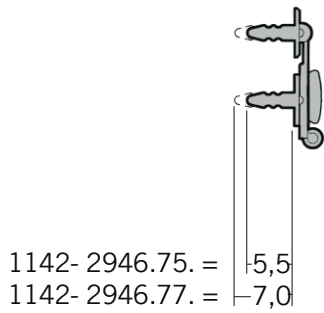
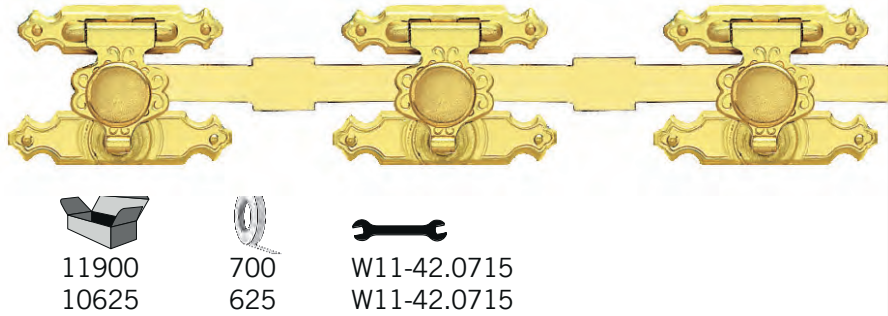
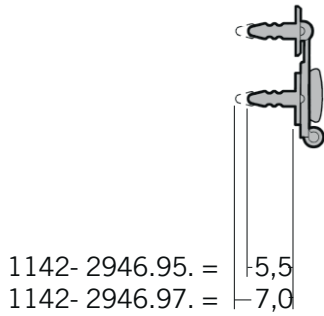

Weitere Varianten auf Anfrage  
 Other variations available upon enquiry  
 Autres variantes sur demande  
 Más variantes a pedido del cliente  
 Altre varianti su richiesta

natürliche Größe  
 actual size  
 grandeur naturelle  
 tamaño natural  
 grandezza naturale

Spitzenverschlüsse mit Druckknopf auf Rollen für flache Deckel  
 Clinch clasps with press button on rolls for flat lids  
 Fermails à griffes avec bouton pression en rouleaux pour couvercles plats  
 Cierres de puntas con botón de presión en rollos para tapas planas  
 Fermagli a punta con bottone a pressione in rotoli per coperchio piatto

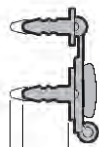

  
 1142- 1383.95. = 5,5  
 1142- 1383.97. = 7,0

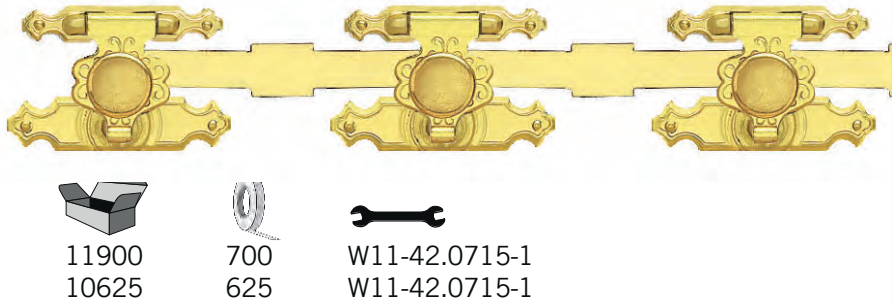

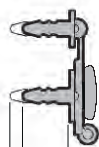
  
 1142- 1383.75. = 5,5  
 1142- 1383.77. = 7,0

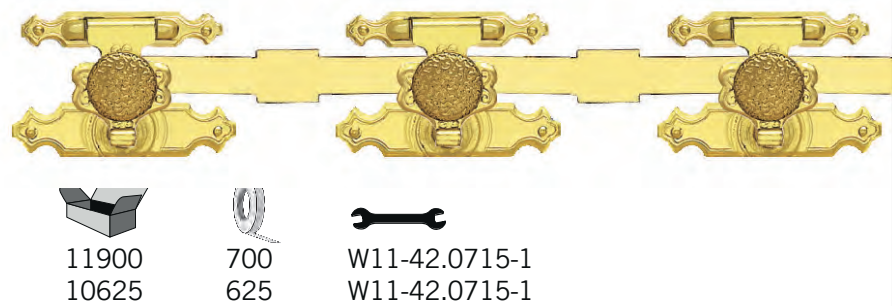

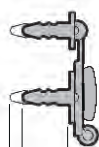
  
 1142- 1383.65. = 5,5  
 1142- 1383.67. = 7,0

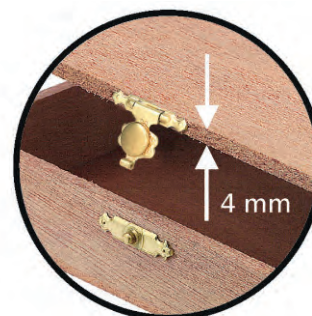
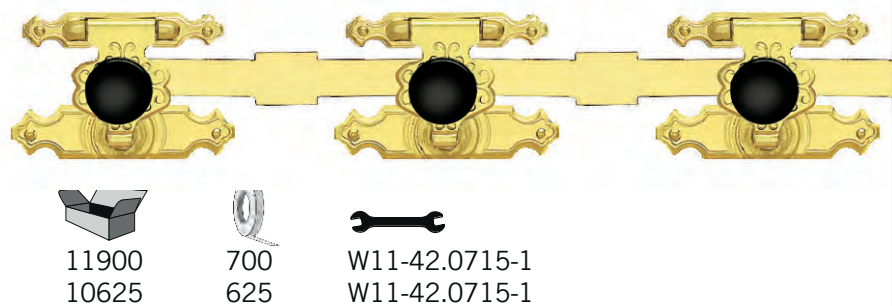



Weitere Varianten auf Anfrage  
 Other variations available upon enquiry  
 Autres variantes sur demande  
 Más variantes a pedido del cliente  
 Altre varianti su richiesta



natürliche Größe  
 actual size  
 grandeur naturelle  
 tamaño natural  
 grandezza naturale

Verschlüsse auf Rollen  
 Clasps on rolls  
 Fermoirs en rouleaux  
 Cierres en rollos  
 Fermagli in rotoli

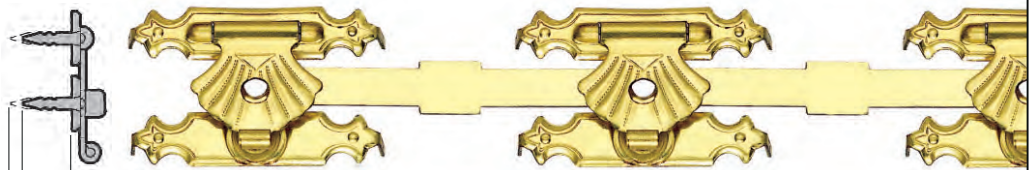

1143- 0775.96. =	6,5		8500		W11-43.0775
1143- 0775.98. =	8,0		7225		W11-43.0775



1143- 0779.96. =	6,5		8500		W11-43.0775
1143- 0779.98. =	8,0		7225		W11-43.0775

Spitzenverschlüsse auf Rollen für flache Deckel  
Clinch clasps on rolls for flat lids  
Fermoirs à griffes en rouleaux pour couvercles plats  
Cierres con puntas en rollos para tapas planas  
Fermagli a punte in rotoli per coperchio piatto

